

04 Leitern

1

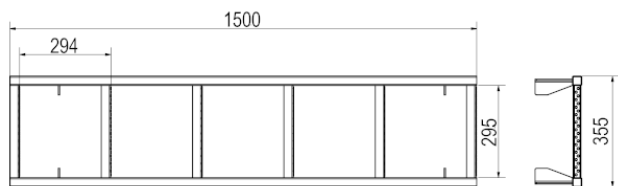

HF-ARC-0233-01

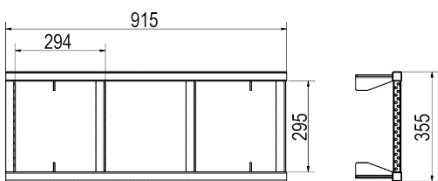
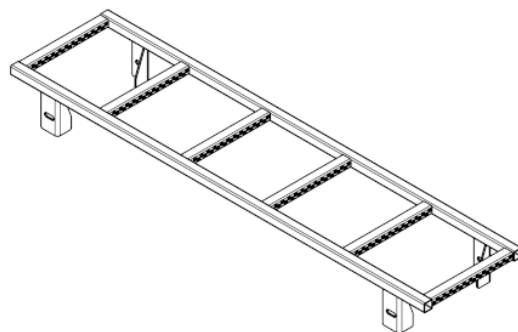

HF-ARC-0233-02

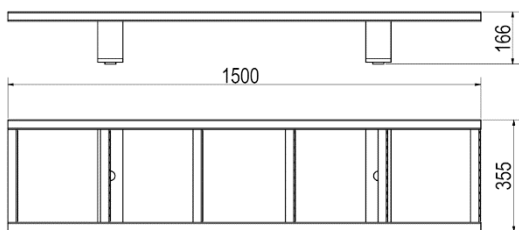
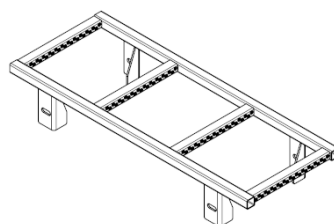

HF-ARC-0233-06

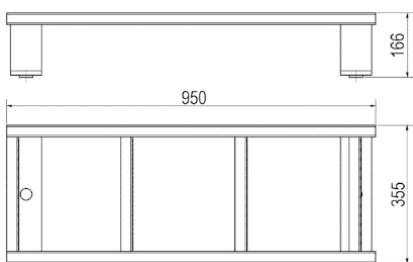
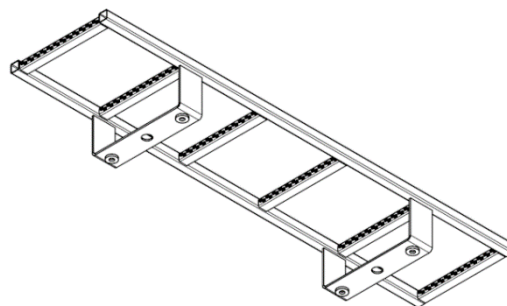

HF-ARC-0233-08

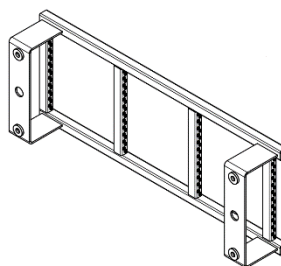

Zeich.-Nr.	Bezeichnung	Abmessung	Bemerkung	Gewicht/ Kg
HF-ARC-0233-01	Steigleiter einteilig	1500 mm	ab Höhe 1750 mm geschraubt; verzinkt	8,70
HF-ARC-0233-02	Steigleiter einteilig	915 mm	ab Höhe 1250 mm geschraubt; verzinkt	6,00
HF-ARC-0233-06	Steigleiter einteilig	1500 mm	ab Höhe 1750 mm geschraubt; verzinkt	9,20
HF-ARC-0233-08	Steigleiter einteilig	950 mm	ab Höhe 1250 mm geschraubt; verzinkt	8,30

04 Leitern

2

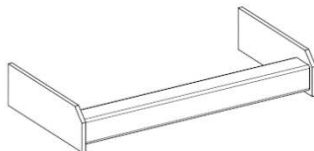
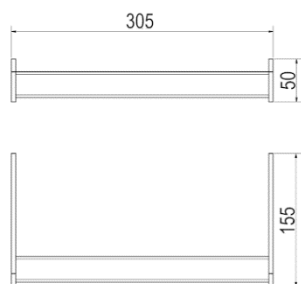

HF-ARC-0011-01

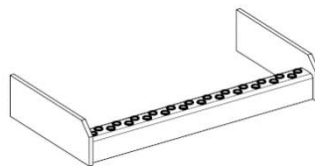
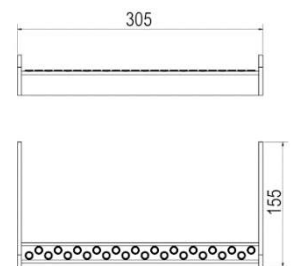

HF-ARC-0011-02

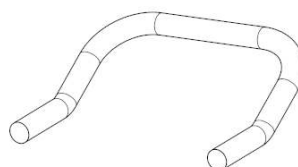
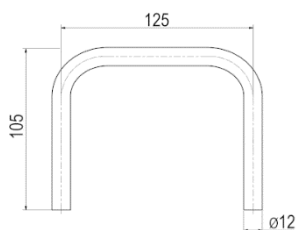

HF-ASC-0049-01

Zeich.-Nr.	Bezeichnung	Abmessung	Bemerkung	Gewicht/ Kg
HF-ARC-0011-01	Steigleiterstufe	Tritt 30 x 30 mm	1-fach	1,30
HF-ARC-0011-02	Steigleiterstufe		1-fach mit Lochprofil	1,20
HF-ASC-0049-01	Bügel		Haltegriff	0,30